

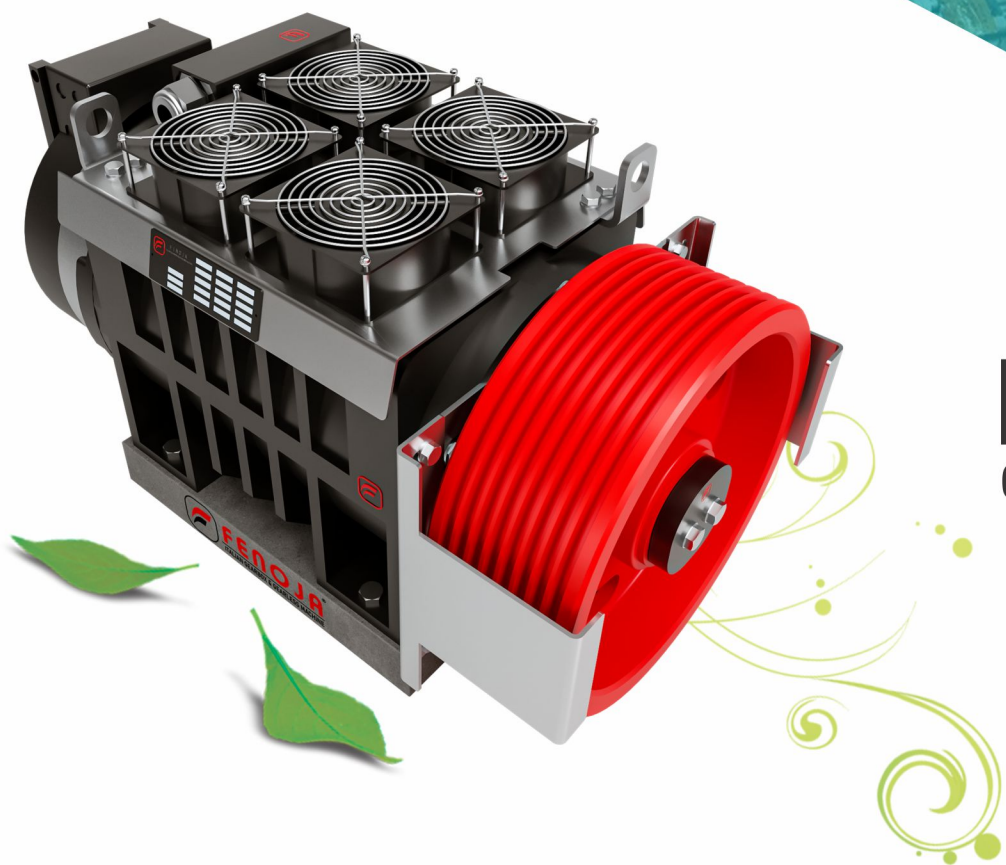

FENOJA[®]
ITALIAN GEARBOX & GEARLESS MACHINE

**New Generation
Permanent Magnet
Synchronous Gearless
Traction m/c.**



FIL-75L
Gearless Machine



**No Machine Room
Require**



Save Energy



Low Noise

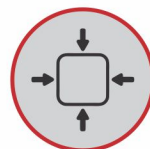

Compact Designs



**Technology
Collaboration by Italy**

www.fenoja.com



FIL-75L

Gearless Machine

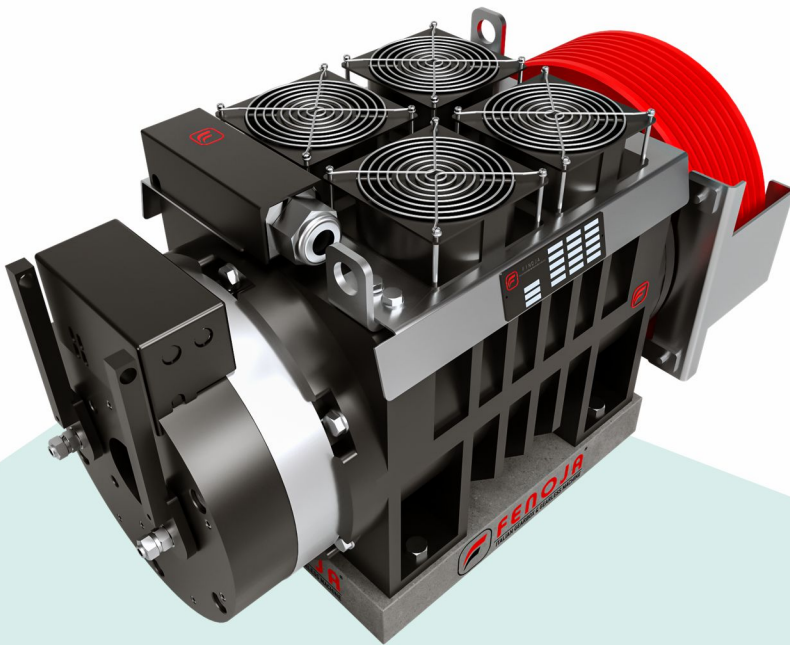

Static load	3.400 kg
Capacity	1,600 kg 2:1
Torque moment	630 Nm-S5-40ED-180 av/h
Pulley	240 – 320 mm
Gearless weight	240 kg
Voltage	380 V
Encoder	ERN1387 HEIDENHAIN

Fenoja FIL75L the perfect gearless for 3480 kg load

Fenoja FIL75L Gearless Motor is the most trusted and advanced lift system in the indigenous market.

When maximizing the needs of installation cost minimization with safety ride & comfort.



www.fenoja.com

FIL-75L

Gearless Machine

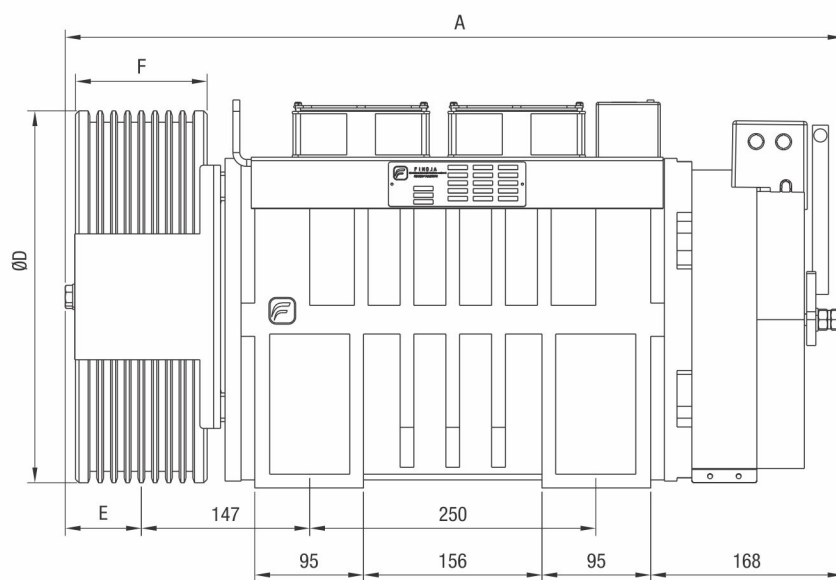
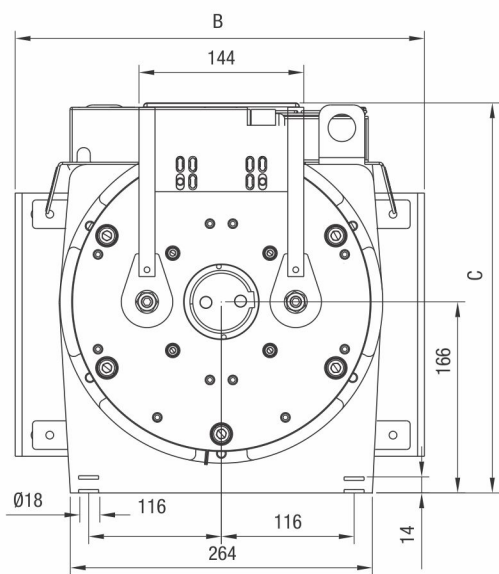
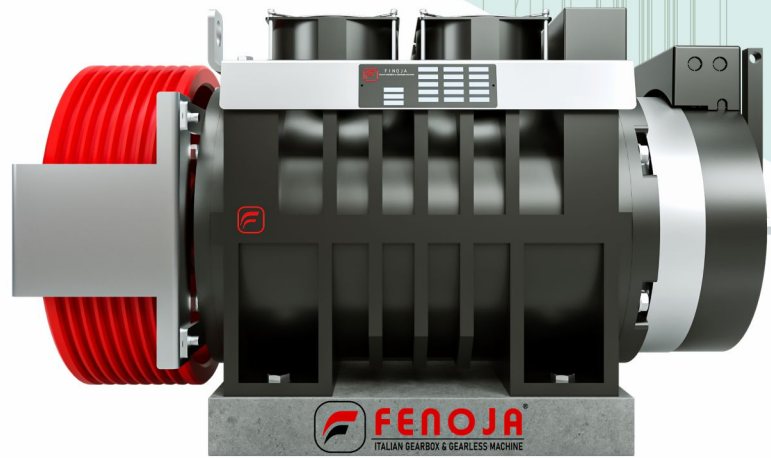

(ALL DIMENSIONS ARE IN MM) •
SUBJECT TO CHANGE WITHOUT ANY PRIOR NOTICE! •



LOAD	SPEED	Ø	ROPES	PITCH	TORQUE	POWER	RPM	FREQ	CURRENT 380V
KG	M/S	MM	MAX	MM	NM	K.W	RPM	Hz	A
1,6	0,5	320	8xØ8	17	622	3,9	59,7	8,0	14,8
	0,63	320	8xØ8	17	622	4,9	75,2	10,0	21,7
	1	320	8xØ8	17	622	7,8	119,4	15,9	21,7
	1,5	320	8xØ8	17	622	11,7	179,0	23,9	31,6
	1,6	320	8xØ8	17	622	12,4	191,0	25,5	31,6
	1,75	320	8xØ8	17	622	13,6	208,9	27,9	31,6
	2	320	8xØ8	17	622	15,5	238,7	31,8	39,5
	2,5	320	8xØ8	17	622	19,4	298,4	39,8	51,3
	3	320	8xØ8	17	622	23,3	358,1	47,7	51,3
2,5	0,5	240	10xØ6,5	12	596	5,0	79,6	10,6	20,8
	0,63	240	10xØ6,5	12	596	6,3	100,3	13,4	20,8
	1	240	10xØ6,5	12	596	9,9	159,2	21,2	26,5
	1,5	240	10xØ6,5	12	596	14,9	238,7	31,8	37,8
	1,6	240	10xØ6,5	12	596	15,9	254,6	34,0	37,8
	1,75	240	10xØ6,5	12	596	17,4	278,5	37,1	49,2
	2	240	10xØ6,5	12	596	19,9	318,3	42,4	49,2

2:01

www.fenoja.com

New Generation Permanent Magnet Synchronous Gearless Traction m/c.



India Factory Warehouse :

 Malayapur, Raghunathpur,
24 PGS North, **Baduria** - 743401
West Bengal, India

 +91-9735-02-0007
03217-235003

 info@fenoja.com

 www.fenoja.com

