

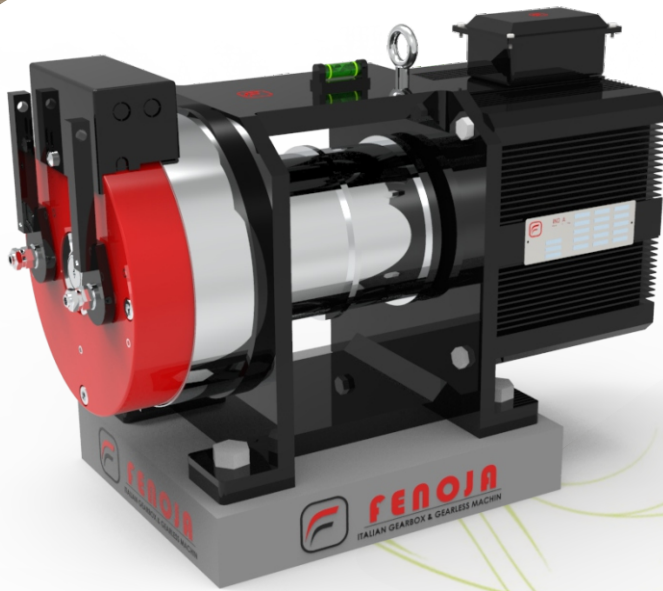

FENOJA[®]
ITALIAN GEARBOX & GEARLESS MACHINE

**New Generation
Permanent Magnet
Synchronous Gearless
Traction m/c.**



FENO-150S
Gearless Machine



**No Machine Room
Require**



Save Energy



Low Noise

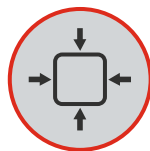

Compact Designs



**Technology
Collaboration by Italy**

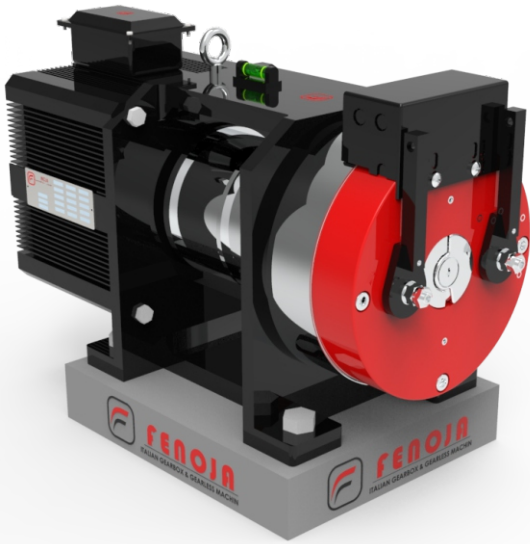

FENO-150S

Gearless Machine

Load	320 ~ 450 kg	Speed	0.3 ~ 1.0m/s
Roping	2:1,1:1	Static Load	3000 kg
Voltage	380v,220V	INS.Class	F
IP Code	IP41	Poles	16
Brake Vol	DC110V	Brake Current	1.1A
Working System	S5-25%		

Size Specification Table

Roping	Spec	L (mm)	L1 (mm)
2:1	FINO320/400/450	505	290
1:1	FINO250Y	505	290
1:1	FINO320Y/400Y	555	340



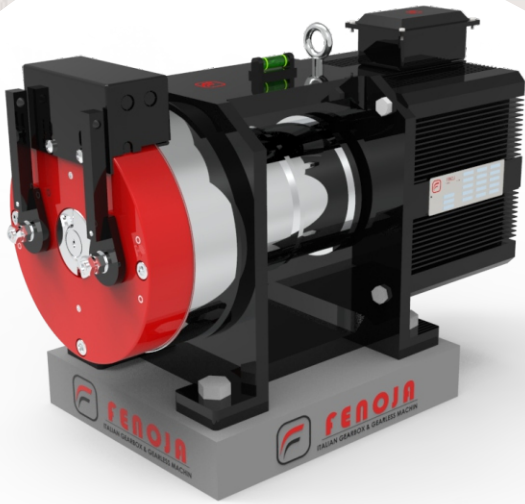

FENO-150S

Gearless Machine

New Generation
Permanent Magnet
Synchronous Gearless
Traction m/c.

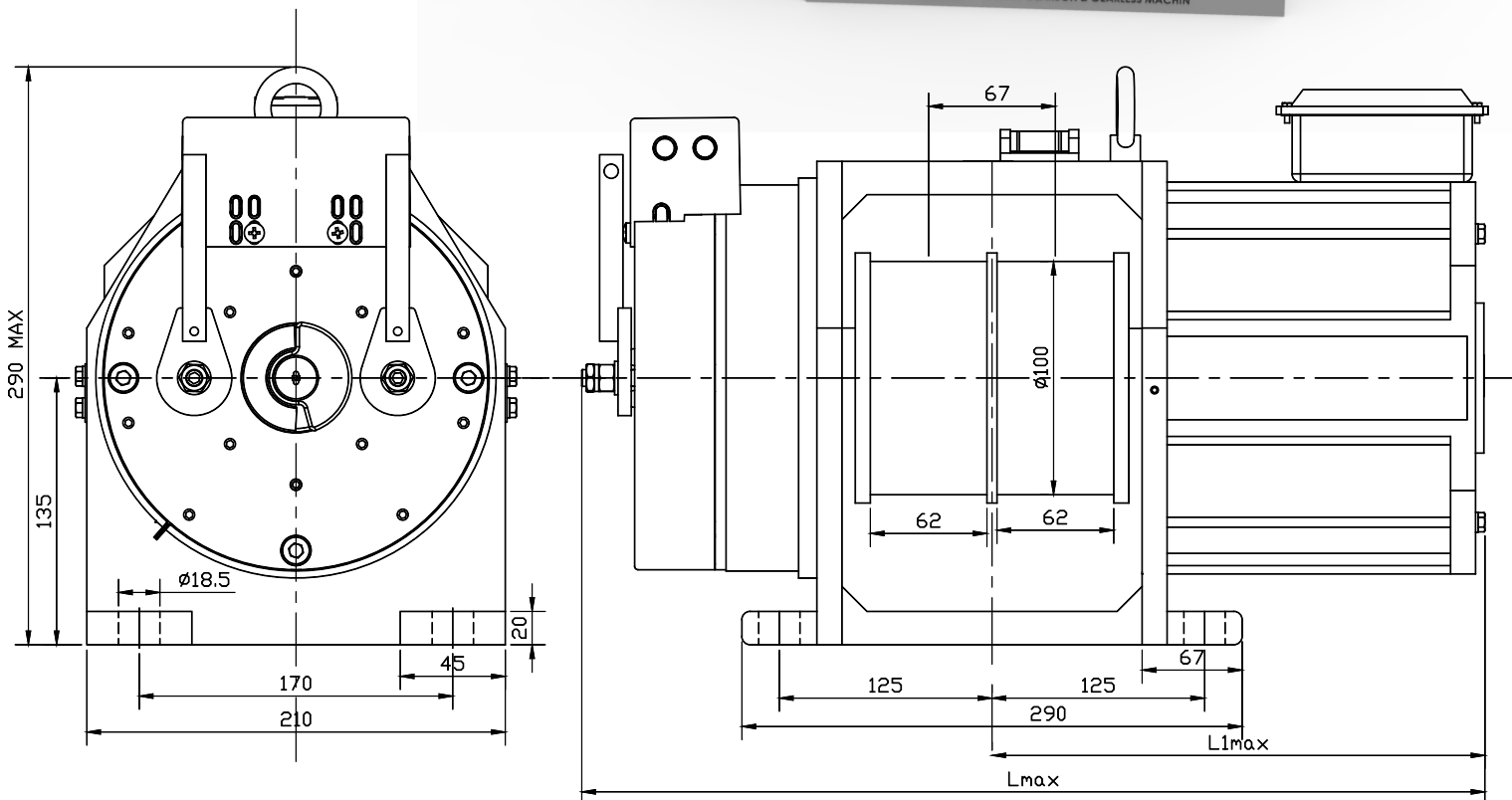
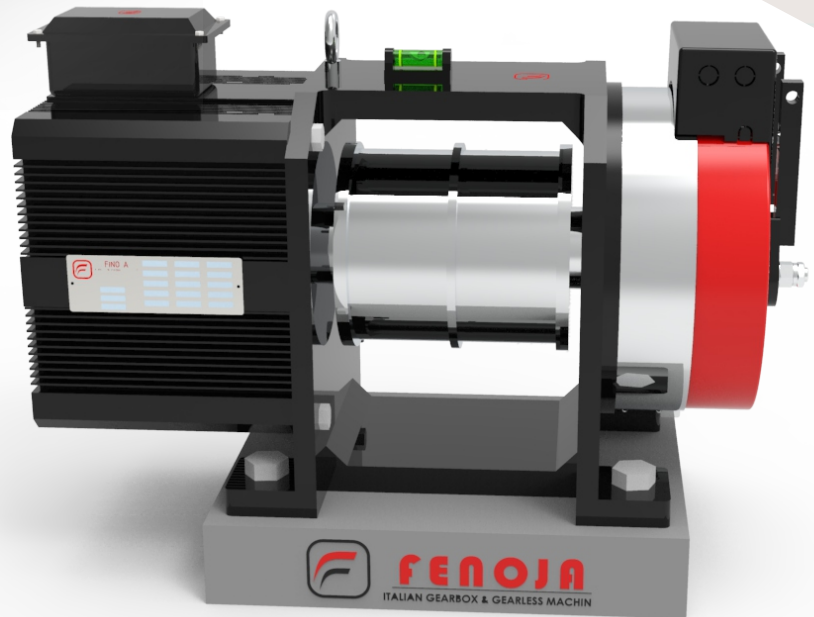

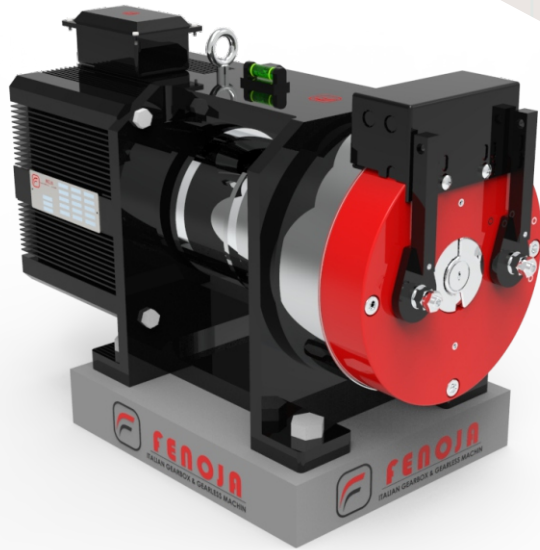

FENO-150S

Gearless Machine

FENOJA150S Series Gearless Traction Machine Specification (Roping 2:1)

Type	Load (kg)	speed (m/s)	Power (kw)	Current(A) 380V/220V	Speed (rpm)	Frequency(Hz)	Torque(N.m)	Sheave(mm)	Rope(nxa-b)	Net Weight(kg)
FINO320	320	0.3	0.7	4.4/4.4	115	15.3	55	100	2X30-65	70
	320	0.4	0.9	4.4/4.4	153	20.4	55	100	2X30-65	70
	320	0.5	1.1	3/5.2	191	25.5	55	100	2X30-65	70
	320	0.63	1.3	3/5.2	241	32.1	55	100	2X30-65	70
	320	1.0	2.2	5.3/9.2	382	50.9	55	100	2X30-65	70
FINO400	400	0.3	0.9	5.5/5.5	115	15.3	70	100	2X30-65	70
	400	0.4	1.1	5.5/5.5	153	20.4	70	100	2X30-65	70
	400	0.5	1.3	3.8/6.5	191	25.5	70	100	2X30-65	70
	400	0.63	1.7	3.8/6.5	241	32.1	70	100	2X30-65	70
	400	1.0	2.7	6.7/11.6	382	50.9	70	100	2X30-65	70
FINO450	450	0.4	1.3	6.2/6.2	153	20.4	80	100	2X30-65	70
	450	0.5	1.6	4.3/7.4	191	25.5	80	100	2X30-65	70
	450	0.63	1.9	4.3/7.4	241	32.1	80	100	2X30-65	70
	450	1.0	3.2	7.5/13	382	50.9	80	100	2X30-65	70

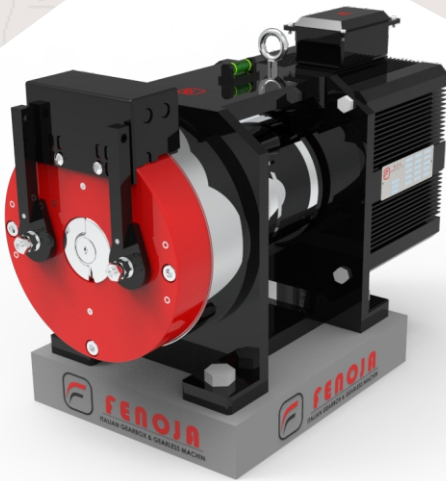

FENO-150S

Gearless Machine

FENOJA150S Series Gearless Tracēon Machine Specīcaēon (Roping 1:1)										
Type	Load (kg)	speed (m/s)	Power (kw)	Current(A) 380V/220V	Speed (rpm)	Frequency(Hz)	Torque(N.m)	Sheave(mm)	Rope(nxa-b)	Net Weight(kg)
FINO250 Y	250	0.3	0.52	3/5.2	57	7.6	85	100	2X30-65	70
	250	0.4	0.7	3/5.2	76	10.1	85	100	2X30-65	70
	250	0.5	0.9	3.3/5.8	95	12.7	85	100	2X30-65	70
FINO320 Y	320	0.3	0.7	3.6/6.2	57	7.6	110	100	2X30-65	80
	320	0.4	0.9	3.6/6.2	76	10.1	110	100	2X30-65	80
	320	0.5	1.1	4.3/7.4	95	12.7	110	100	2X30-65	80
	320	0.63	1.3	4.3/7.4	120	16	110	100	2X30-65	80
	320	1.0	2.2	5.8/10	191	25.5	110	100	2X30-65	80
FINO400 Y	400	0.3	0.9	4.5/7.8	57	7.6	135	100	2X30-65	80
	400	0.4	1.1	4.5/7.8	76	10.1	135	100	2X30-65	80
	400	0.5	1.3	5.3/9.2	95	12.7	135	100	2X30-65	80
	400	0.63	1.7	5.3/9.2	120	16	135	100	2X30-65	80
	400	1.0	2.7	7.2/12.5	191	25.5	135	100	2X30-65	80

Note: Other Non-Standard Parameter please contact the technical department

New Generation Permanent Magnet Synchronous Gearless Traction m/c.

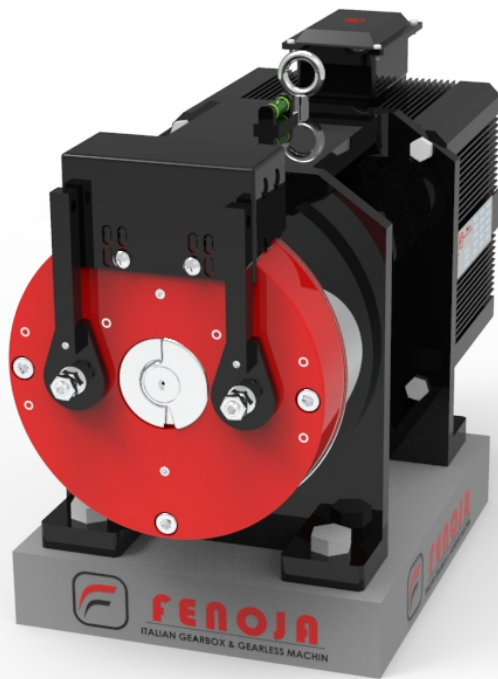

India Factory Warehouse :

 Malayapur, Raghunathpur,
24 PGS North, **Baduria** - 743401
West Bengal, India

 +91-9735-02-0007
03217-235003

 info@fenoja.com

 www.fenoja.com

