

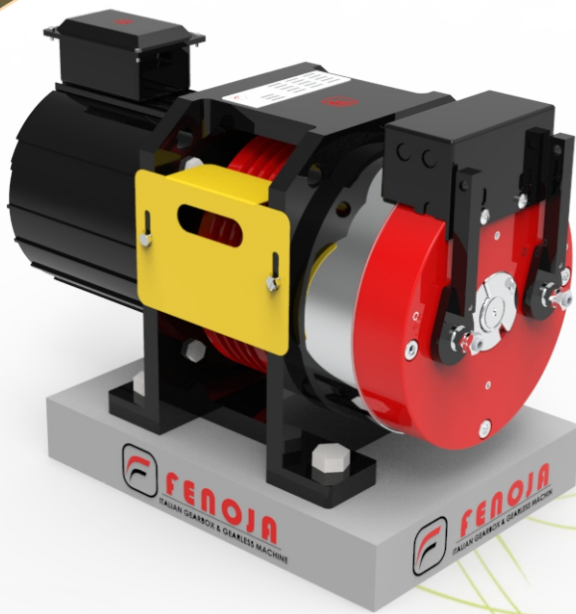

# New Generation Permanent Magnet Synchronous Gearless Traction m/c.



## FENO-2501 Gearless Machine



No Machine Room  
Require



Save Energy



Low Noise

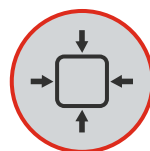

Compact Designs



Technology  
Collaboration by Italy

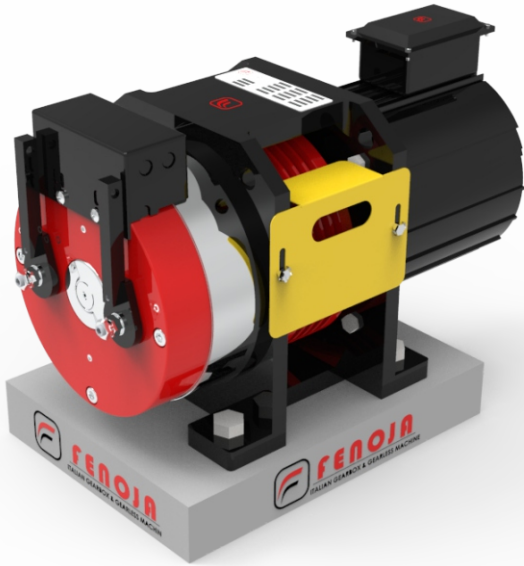

# FENO-2501

## Gearless Machine

Load	320 ~ 800 kg	Speed	0.3 ~ 1.0m/s
Roping	2:1	Static Load	3000 kg
Voltage	380v,220V	INS.Class	F
IP Code	IP41	Poles	16
Brake Vole	DC110V		
Working System	S5-25%		

(Spec.)	D (Mm)	L (mm)	L1 (mm)
FINO320	200	430	225
FINO400/450	200	445	240
FINO320/400/450	240	460	255
FINO630	200	500	290
FINO630	240	500	290
FINO800	240	530	320



www.fenoja.com



# FENO-2501

## Gearless Machine

New Generation  
Permanent Magnet  
Synchronous Gearless  
Traction m/c.

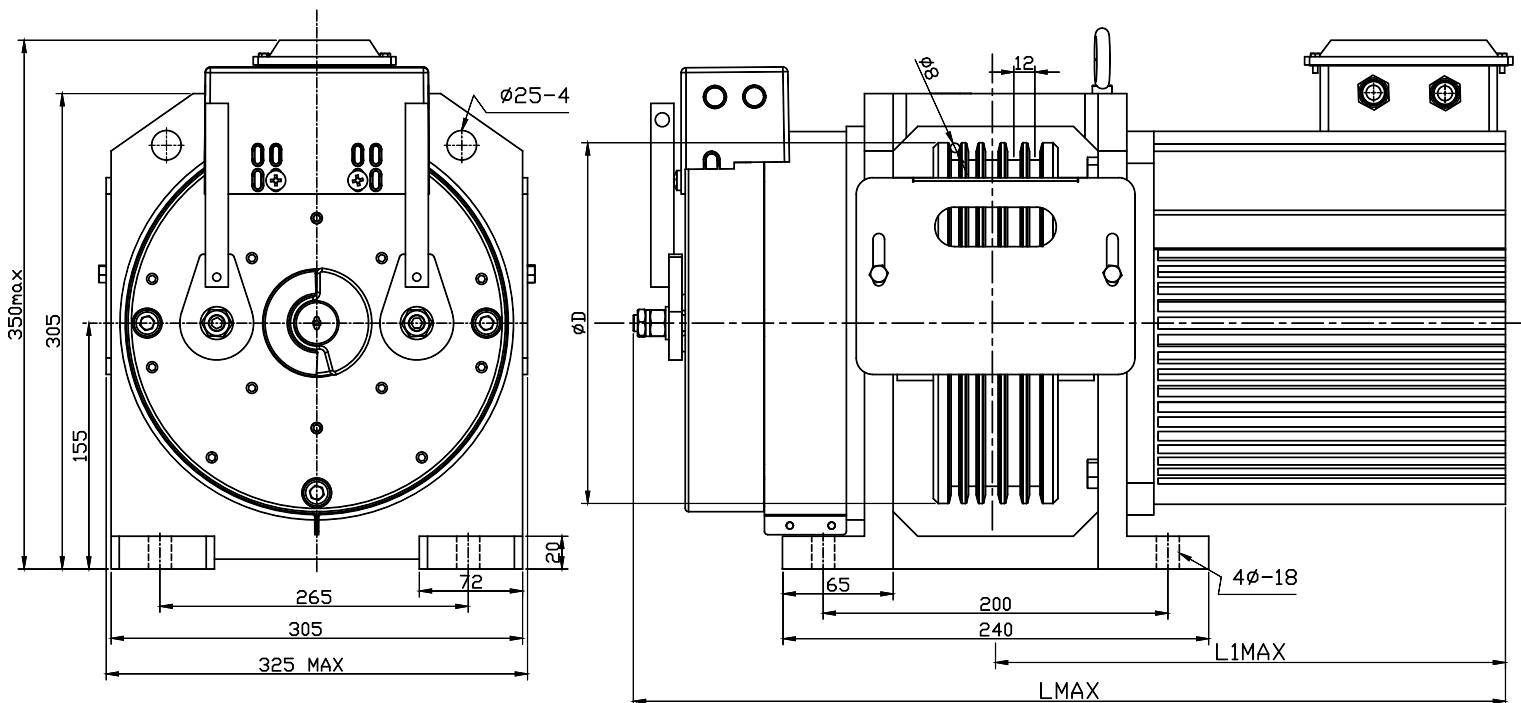
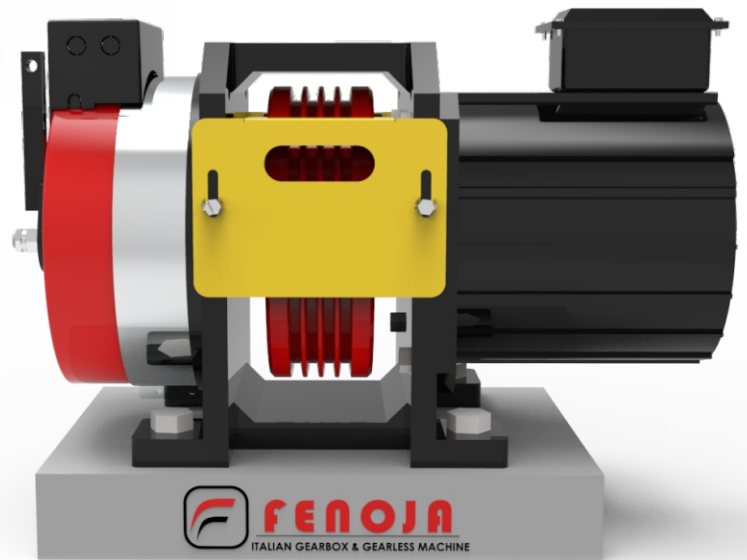

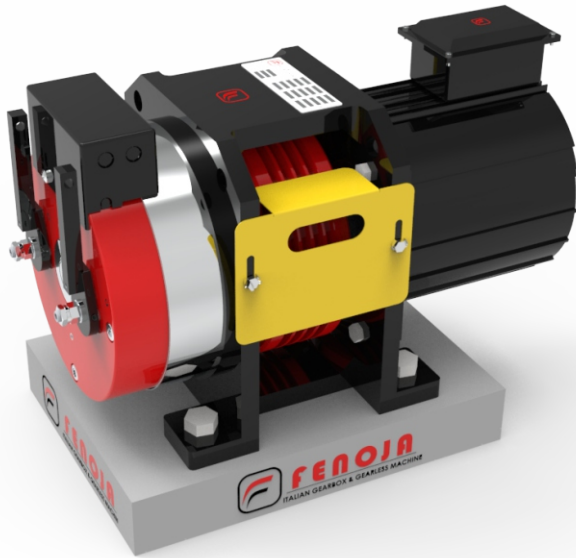

# FENO-2501

## Gearless Machine



FENOJA250-1 Series Gearless Traction Machine Specification (Roping 2:1)

Type	Load (kg)	speed (m/s)	Power (kw)	Current(A) 380V/220V	Speed (rpm)	Frequency (Hz)	Torque (N.m)	Sheave (mm)	Rope (nxa-b)	Brake Current (A)	Net Weight(kg)
FINO320	320	0.3	0.7	3.4/5.8	57	7.6	110	200	3XØ8-12	1.5	70
	320	0.4	0.9	3.4/5.8	76	10.1	110	200	3XØ8-12	1.5	70
	320	0.5	1.1	3.8/6.5	96	12.8	110	200	3XØ8-12	1.5	70
	320	0.63	1.3	3.8/6.5	120	16	110	200	3XØ8-12	1.5	70
	320	1.0	2.2	5.3/9.2	191	25.5	110	200	3XØ8-12	1.5	70
FINO400	400	0.3	0.9	4/6.9	57	7.6	135	200	3XØ8-12	1.5	75
	400	0.4	1.1	4/6.9	76	10.1	135	200	3XØ8-12	1.5	75
	400	0.5	1.3	4.5/7.8	96	12.8	135	200	3XØ8-12	1.5	75
	400	0.63	1.7	4.5/7.8	120	16	135	200	3XØ8-12	1.5	75
	400	1.0	2.7	6.2/10.8	191	25.5	135	200	3XØ8-12	1.5	75
FINO450	450	0.4	1.3	4.5/7.8	76	10.1	150	200	4XØ6-12	1.5	75
	450	0.5	1.6	5.1/8.8	96	12.8	150	200	4XØ6-12	1.5	75
	450	0.63	1.9	5.1/8.8	120	16	150	200	4XØ6-12	1.5	75
	450	1.0	3.2	6.9/12	191	25.5	150	200	4XØ6-12	1.5	75
FINO630	630	0.4	1.7	6.5/11.3	76	10.1	210	200	5XØ8-12	1.75	130
	630	0.5	2.1	6.5/11.3	96	12.8	210	200	5XØ8-12	1.75	130
	630	0.63	2.7	6.5/11.3	120	16	210	200	5XØ8-12	1.75	130
	630	1.0	4.2	9.5/16.5	191	25.5	210	200	5XØ8-12	1.75	130

Note: Other Non-Standard Parameter please contact the technical department

# New Generation Permanent Magnet Synchronous Gearless Traction m/c.

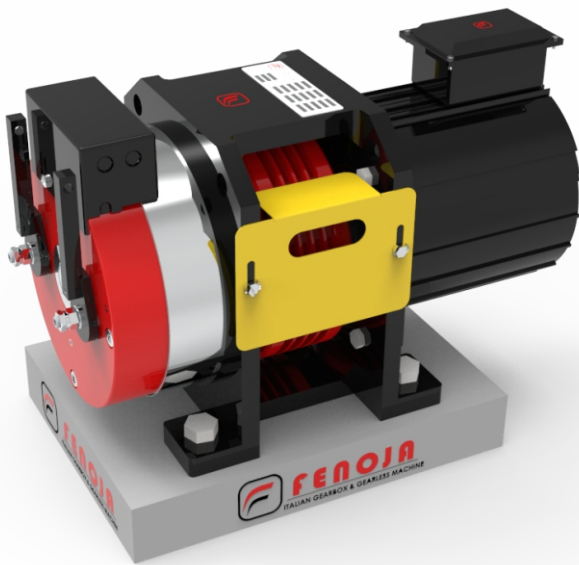

India Factory Warehouse :

📍 Malayapur, Raghunathpur,  
24 PGS North, **Baduria** - 743401  
West Bengal, India

☎ +91-9735-02-0007  
03217-235003

✉ info@fenoja.com

🌐 www.fenoja.com

