

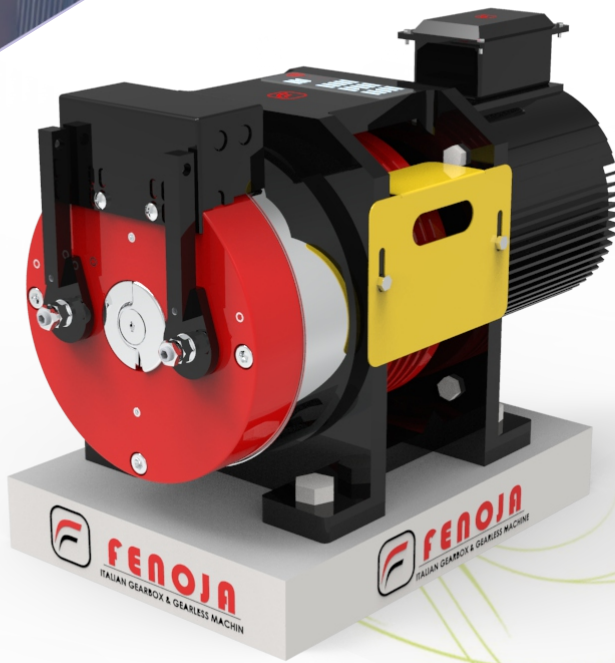

FENOJA[®]
ITALIAN GEARBOX & GEARLESS MACHINE

**New Generation
Permanent Magnet
Synchronous Gearless
Traction m/c.**



FENO-2502
Gearless Machine



**No Machine Room
Require**



Save Energy



Low Noise

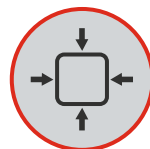

Compact Designs



**Technology
Collaboration by Italy**

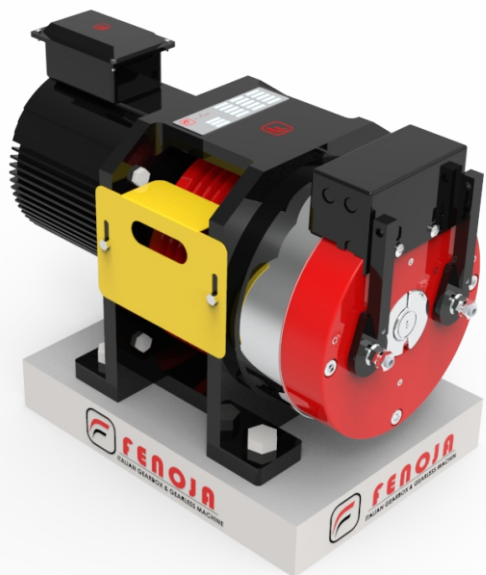

FENO-2502

Gearless Machine

Load	320 ~ 450 kg	Speed	0.3 ~ 1.0m/s
Roping	2:1	Static Load	3000 kg
Voltage	380v,220V	INS.Class	F
IP Code	IP41	Poles	16
Brake Vol	DC110V	Brake Current	1.5A
Working System	S5-25%		

(Spec.)	L (mm)	L1 (mm)
FINO320	405	210
FINO400/450	420	225



www.fenoja.com

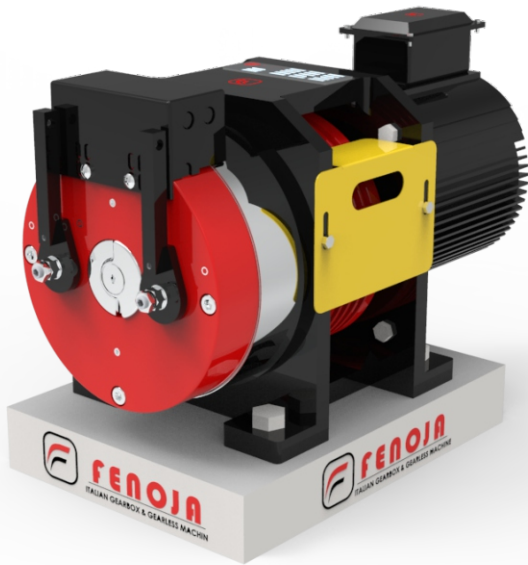

FENO-2502

Gearless Machine

**New Generation
Permanent Magnet
Synchronous Gearless
Traction m/c.**

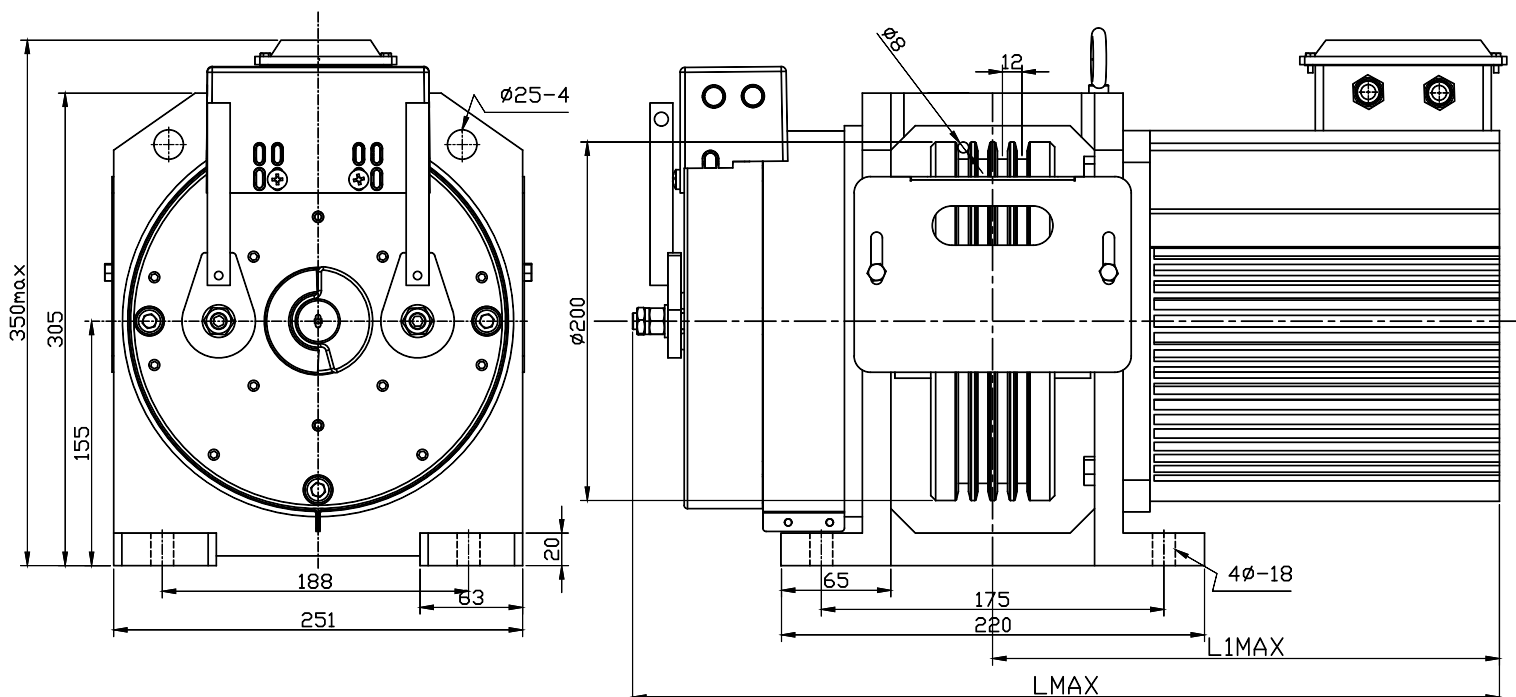
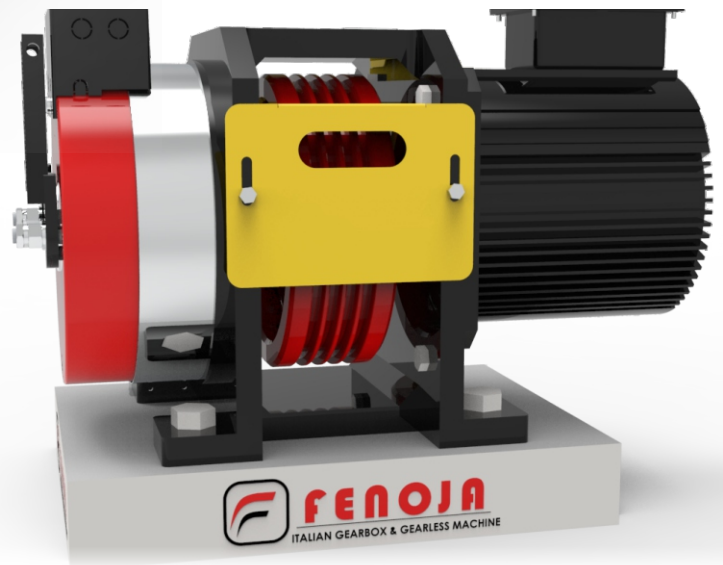

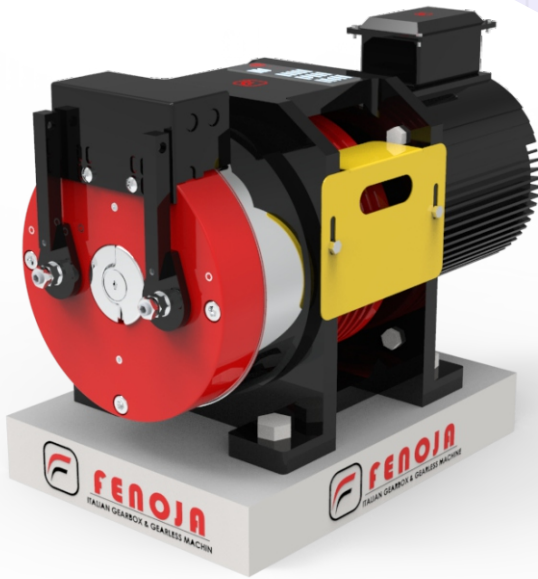

FENO-2502

Gearless Machine

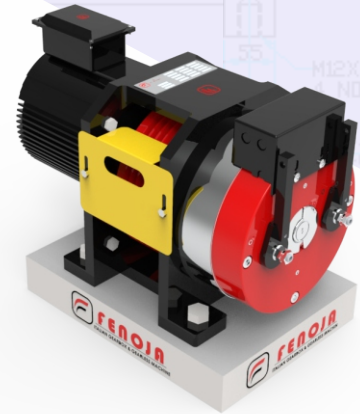

FENOJA250-2 Series Gearless Traction Machine Specification (Roping 2:1)

Type	Load (kg)	speed (m/s)	Power (kw)	Current (A) 380V/220V	Speed (rpm)	Frequenc y (Hz)	Torque (N.m)	Sheave (mm)	Max.static Load (kg)	Net Weight (kg)
FINO320	320	0.3	0.7	3.4/5.8	57	7.6	110	200	3 X Ø8-12	70
	320	0.4	0.9	3.4/5.8	76	10.1	110	200	3 X Ø8-12	70
	320	0.5	1.1	3.8/6.5	96	12.8	110	200	3 X Ø8-12	70
	320	0.63	1.3	3.8/6.5	120	16	110	200	3 X Ø8-12	70
	320	1.0	2.2	5.3/9.2	191	25.5	110	200	3 X Ø8-12	70
FINO400	400	0.3	0.9	4/6.9	57	7.6	135	200	3 X Ø8-12	75
	400	0.4	1.1	4/6.9	76	10.1	135	200	3 X Ø8-12	75
	400	0.5	1.3	4.5/7.8	96	12.8	135	200	3 X Ø8-12	75
	400	0.63	1.7	4.5/7.8	120	16	135	200	3 X Ø8-12	75
	400	1.0	2.7	6.2/10.8	191	25.5	135	200	3 X Ø8-12	75
FINO450	450	0.4	1.3	4.5/7.8	76	10.1	150	200	4 X Ø8-12	75
	450	0.5	1.6	5.1/8.8	96	12.8	150	200	4 X Ø8-12	75
	450	0.63	1.9	5.1/8.8	120	16	150	200	4 X Ø8-12	75
	450	1.0	3.2	6.9/12	191	25.5	150	200	4 X Ø8-12	75

Note: Other Non-Standard Parameter please contact the technical department

New Generation Permanent Magnet Synchronous Gearless Traction m/c.

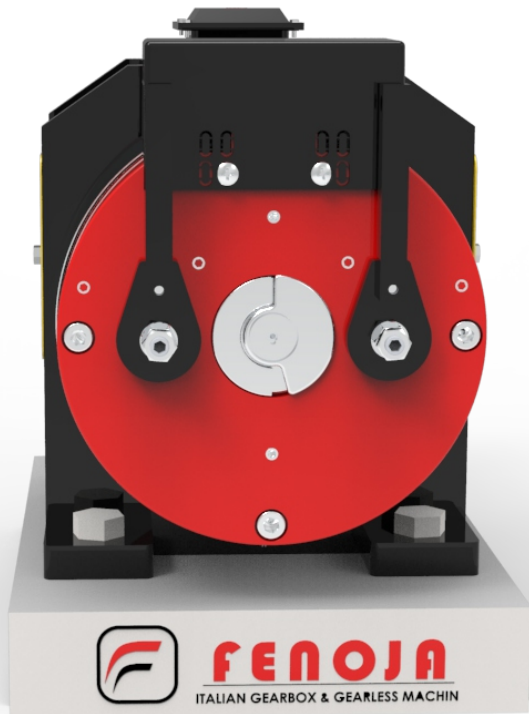

India Factory Warehouse :

📍 Malayapur, Raghunathpur,
24 PGS North, **Baduria** - 743401
West Bengal, India

☎ +91-9735-02-0007
03217-235003

✉ info@fenoja.com

🌐 www.fenoja.com

