



**FENOJA**<sup>®</sup>  
ITALIAN GEARBOX & GEARLESS MACHINE

**New Generation  
Permanent Magnet  
Synchronous Gearless  
Traction m/c.**



**FENO-290**  
Gearless Machine



**No Machine Room  
Require**



**Save Energy**



**Low Noise**

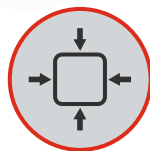

**Compact Designs**



**Technology  
Collaboration by Italy**

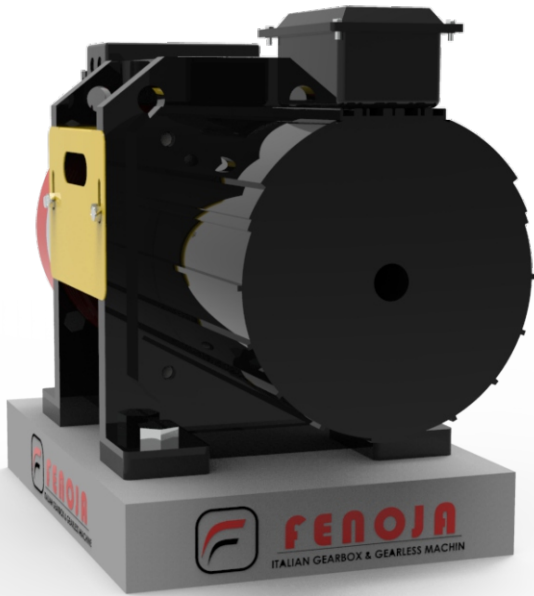

# FENO-290

## Gearless Machine

Load	320 ~ 800 kg	Speed	0.3 ~ 1.0m/s
Roping	2:1	Static Load	3000 kg
Voltage	380v,220V	INS.Class	F
IP Code	IP41	Poles	16
Brake Vole	DC110V		
Working System	S5-25%		

(Spec.)	D (Mm)	L (mm)	L1 (mm)
FINO320	200	430	225
FINO400/450	200	445	240
FINO320/400/450	240	460	255
FINO630	200	500	290
FINO630	240	500	290
FINO800	240	530	320

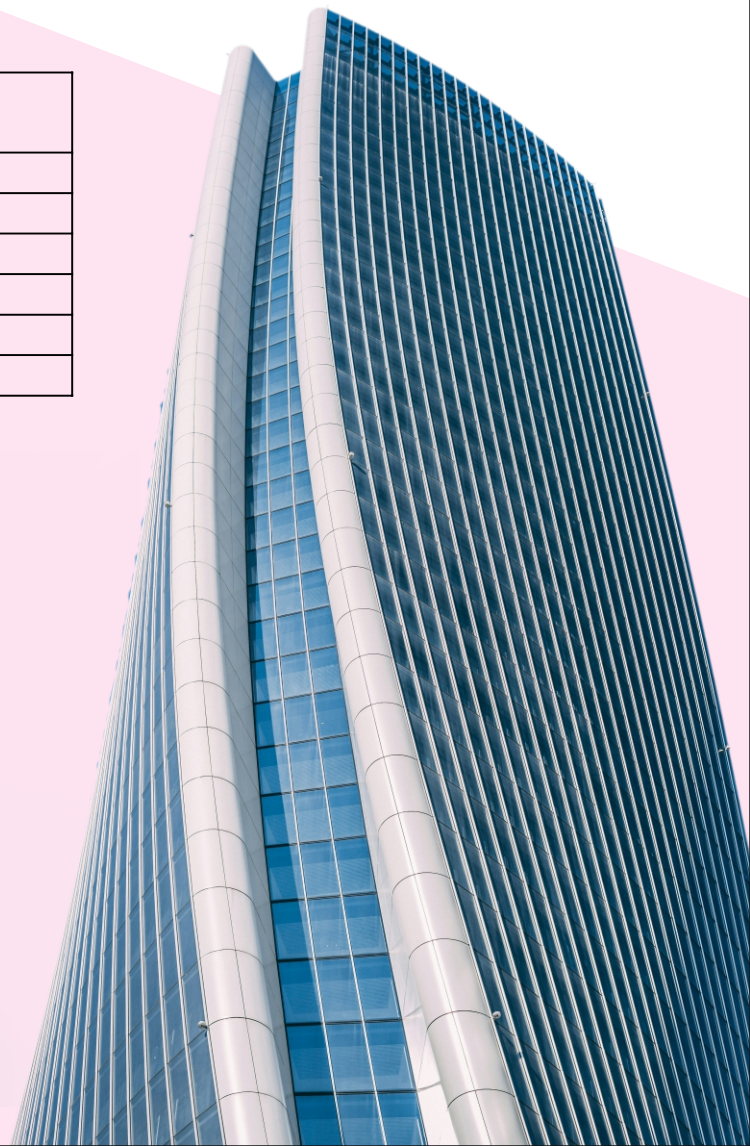
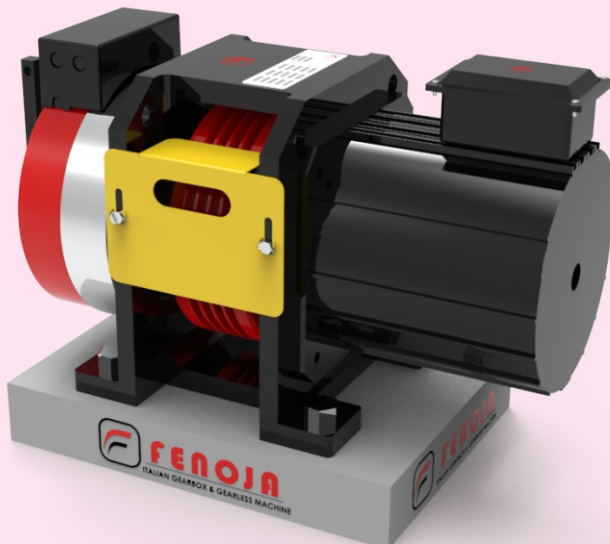

www.fenoja.com



# FENO-290

## Gearless Machine

New Generation  
Permanent Magnet  
Synchronous Gearless  
Traction m/c.

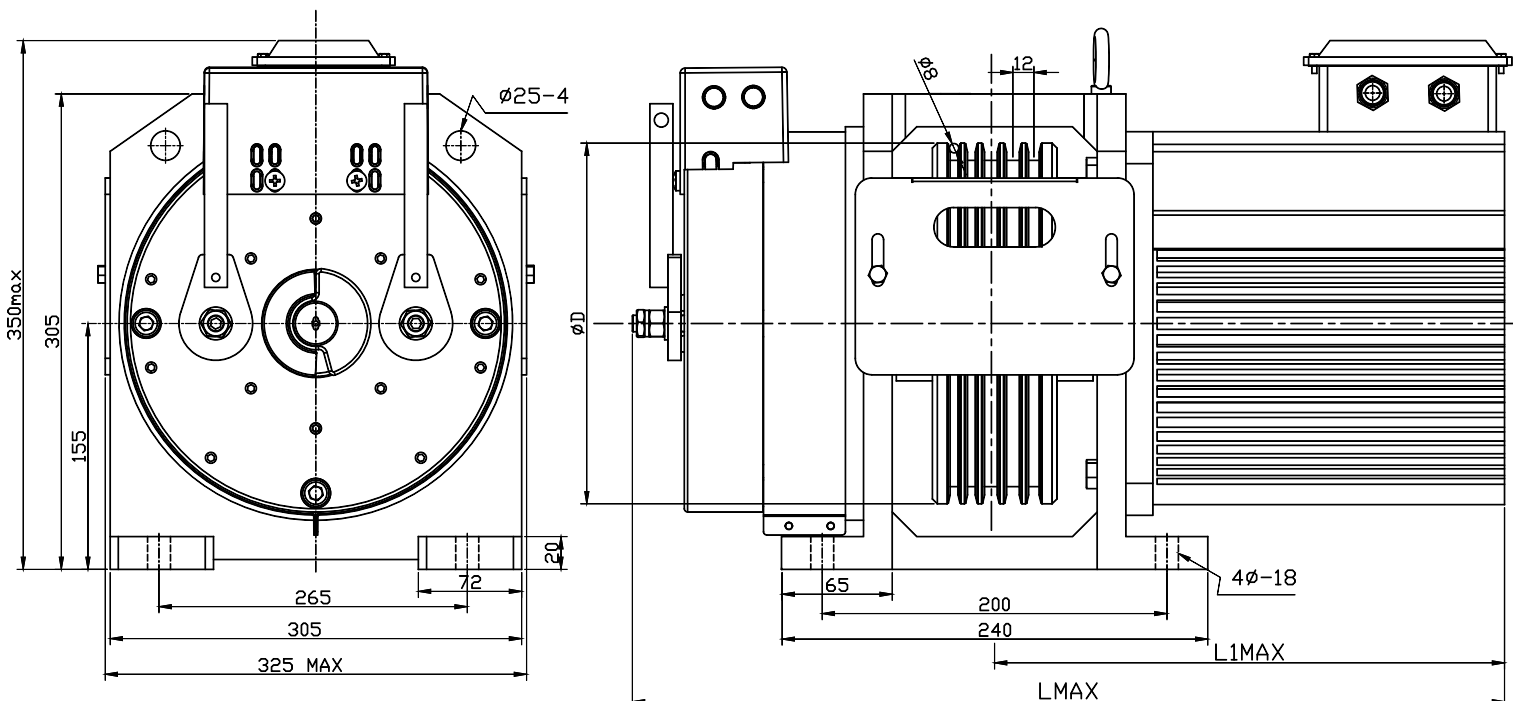
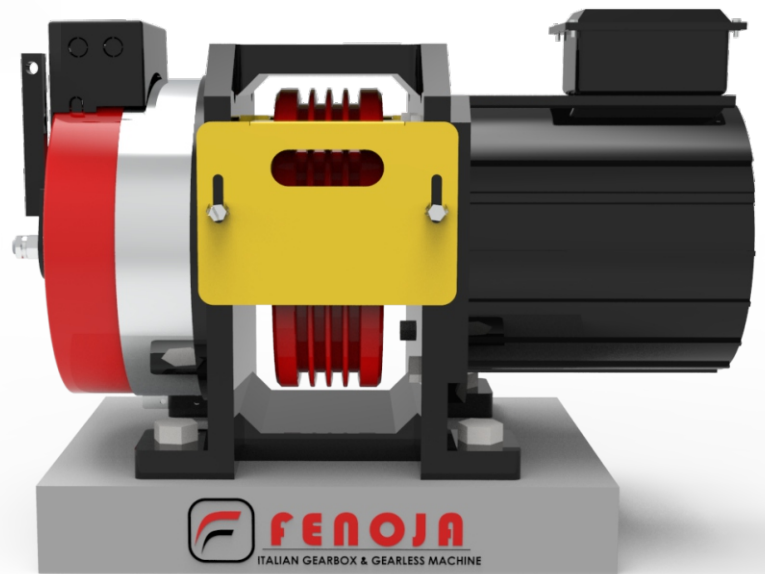

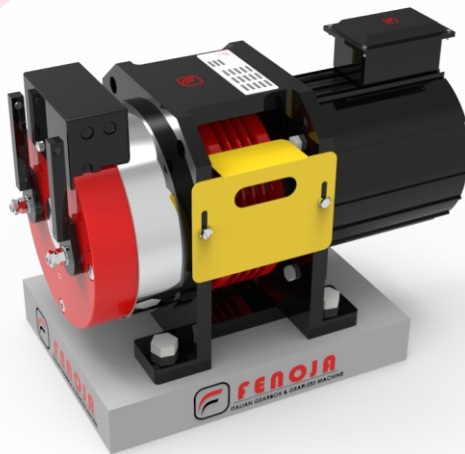

# FENO-290

## Gearless Machine

FENOJA290 Series Gearless Traction Machine Specification (Roping 2:1)											
Type	Load (kg)	speed (m/s)	Power (kw)	Current(A) 380V/220V	Speed (rpm)	Frequency (Hz)	Torque (N.m)	Sheave (mm)	Rope (nxa-b)	Brake Current (A)	Net Weight(kg)
FINO320	320	0.3	0.7	3.6/6.2	48	6.4	130	240	3XØ8-12	1.5	85
	320	0.4	0.9	3.6/6.2	64	8.5	130	240	3XØ8-12	1.5	85
	320	0.5	1.1	4.3/7.5	80	10.7	130	240	3XØ8-12	1.5	85
	320	0.63	1.3	4.3/7.5	100	13.3	130	240	3XØ8-12	1.5	85
	320	1.0	2.2	5.7/9.9	159	21.2	130	240	3XØ8-12	1.5	85
FINO400	400	0.3	0.9	4.5/7.8	48	6.4	160	240	3XØ8-12	1.5	85
	400	0.4	1.1	4.5/7.8	64	8.5	160	240	3XØ8-12	1.5	85
	400	0.5	1.3	5.5/9.6	80	10.7	160	240	3XØ8-12	1.5	85
	400	0.63	1.7	5.5/9.6	100	13.3	160	240	3XØ8-12	1.5	85
	400	1.0	2.7	7.2/12.4	159	21.2	160	240	3XØ8-12	1.5	85
FINO450	450	0.4	1.3	5.1/8.8	64	8.5	180	240	4XØ6-12	1.5	85
	450	0.5	1.6	6.2/10.8	80	10.7	180	240	4XØ6-12	1.5	85
	450	0.63	1.9	6.2/10.8	100	13.3	180	240	4XØ6-12	1.5	85
	450	1.0	3.2	8.1/14	159	21.2	180	240	4XØ6-12	1.5	85
FINO630	630	0.4	1.7	7.8/13.6	64	8.5	250	240	5XØ8-12	1.75	135
	630	0.5	2.1	7.8/13.6	80	10.7	250	240	5XØ8-12	1.75	135
	630	0.63	2.7	7.8/13.6	100	13.3	250	240	5XØ8-12	1.75	135
	630	1.0	4.2	11.5/19.8	159	21.2	250	240	5XØ8-12	1.75	135
FENO800	800	0.5	2.7	8.1/14	80	10.7	320	240	6XØ8-12	1.75	155
	800	0.63	3.4	8.1/14	100	13.3	320	240	6XØ8-12	1.75	155
	800	1.0	5.3	12/20.8	159	21.2	320	240	6XØ8-12	1.75	155

Note: Other Non-Standard Parameter please contact the technical department



# New Generation Permanent Magnet Synchronous Gearless Traction m/c.

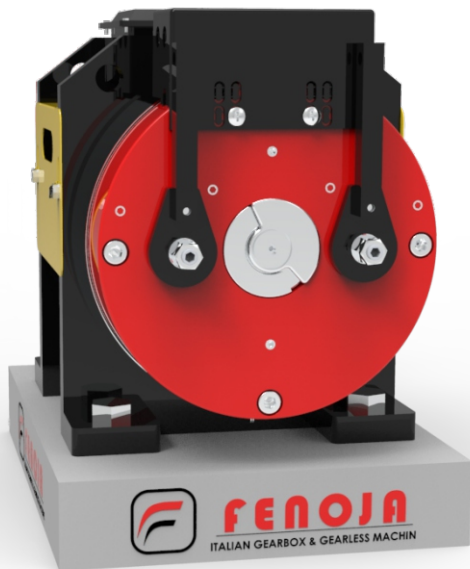

India Factory Warehouse :

 Malayapur, Raghunathpur,  
24 PGS North, **Baduria** - 743401  
West Bengal, India

 +91-9735-02-0007  
03217-235003

 [info@fenoja.com](mailto:info@fenoja.com)

 [www.fenoja.com](http://www.fenoja.com)

