

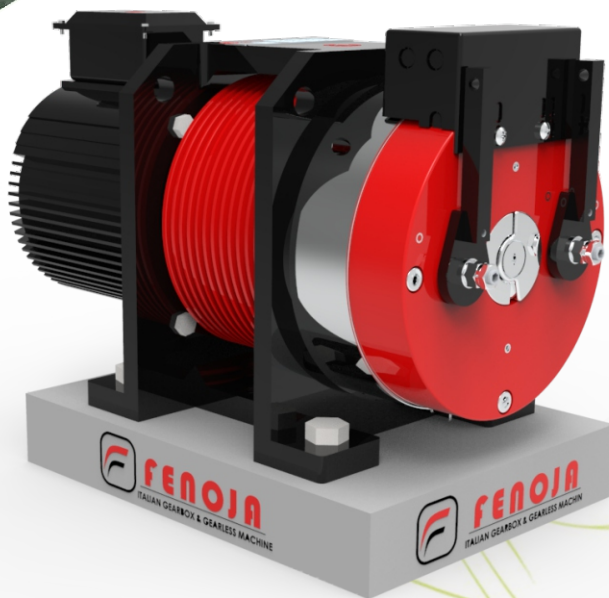

FENOJA[®]
ITALIAN GEARBOX & GEARLESS MACHINE

**New Generation
Permanent Magnet
Synchronous Gearless
Traction m/c.**



FENO-290L
Gearless Machine



**No Machine Room
Require**



Save Energy



Low Noise

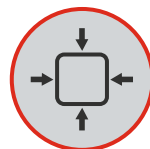

Compact Designs



**Technology
Collaboration by Italy**

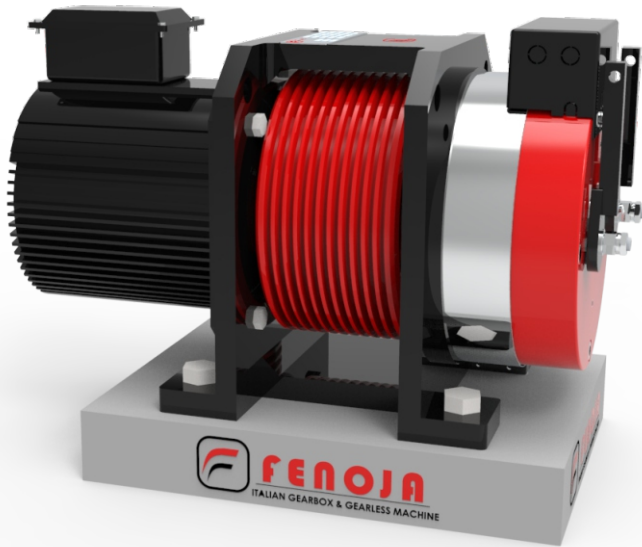

FENO-290L

Gearless Machine

Load	450~1350 kg	Speed	1.0 ~ 1.6m/s
Roping	2:1	Static Load	4000 kg
Voltage	380V	INS.Class	F
IP Code	IP41	Poles	16
Brake Vol	DC110V		
Working System	S5-40%		

(Spec.)	L (mm)	L1 (mm)	L2 (mm)
FINO450	485	265	195
FINO630	510	300	195
FINO800	550	340	195
FINO1000	730	460	283
FINO1250/1350	775	505	283

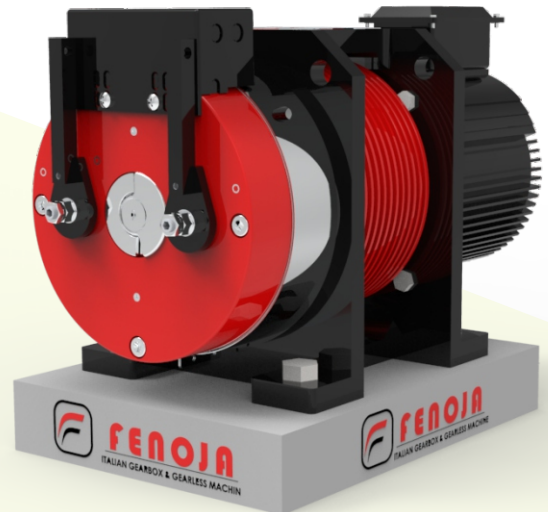

www.fenoja.com

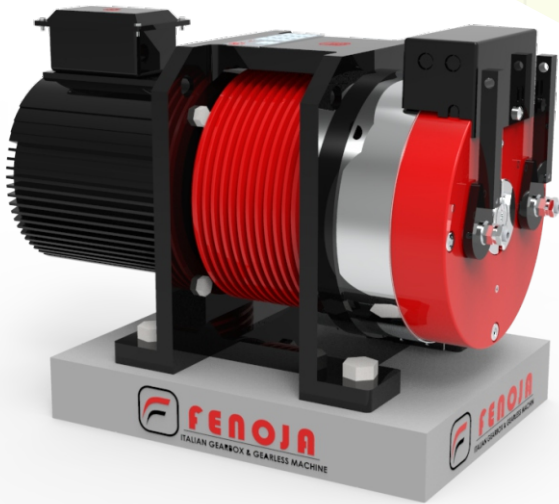

FENO-290L

Gearless Machine

New Generation
Permanent Magnet
Synchronous Gearless
Traction m/c.

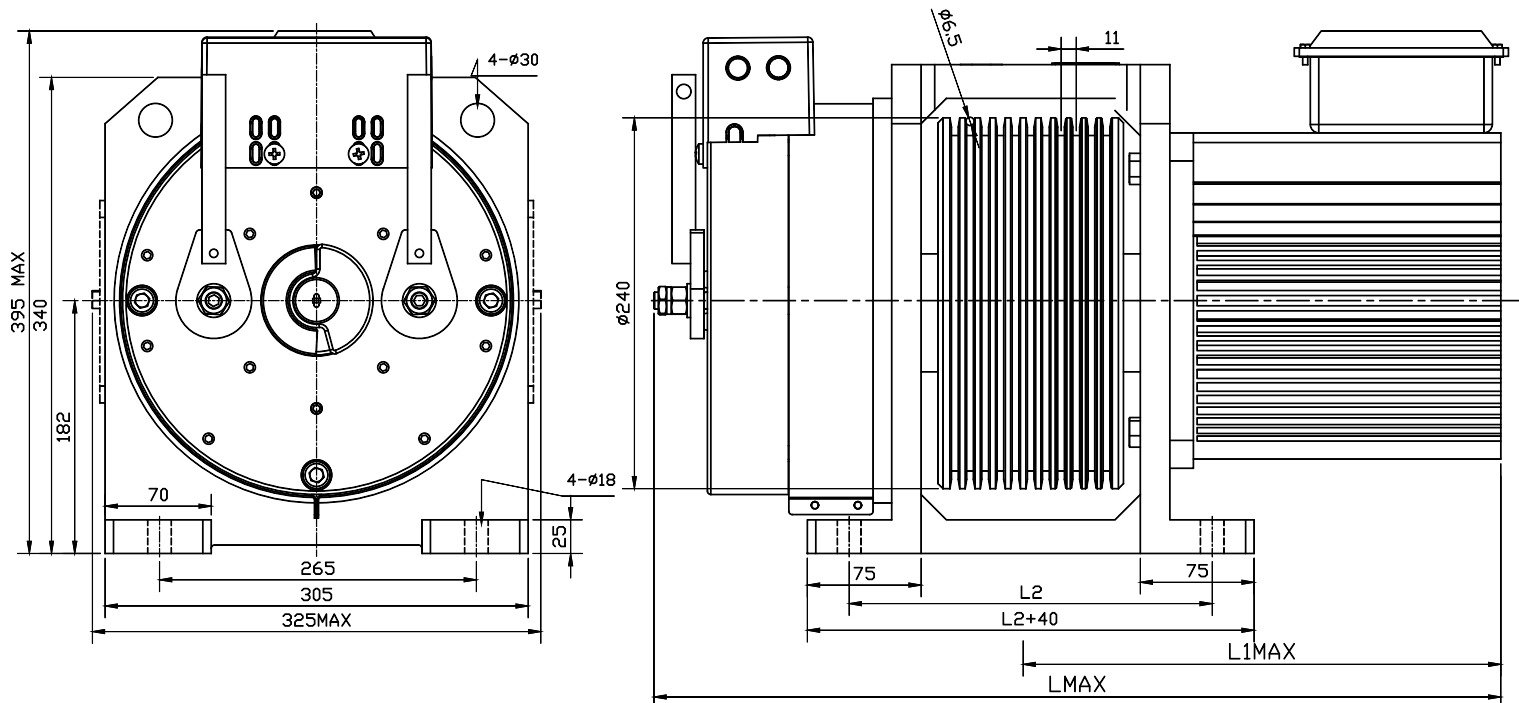
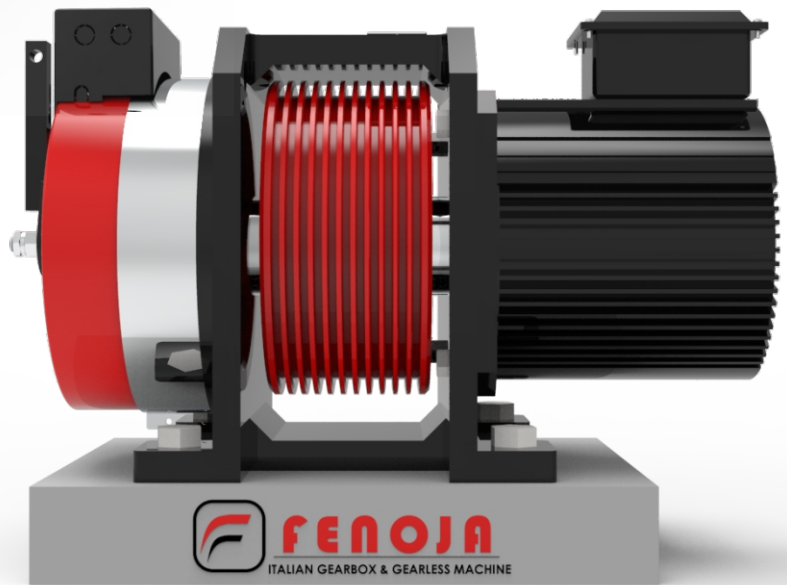

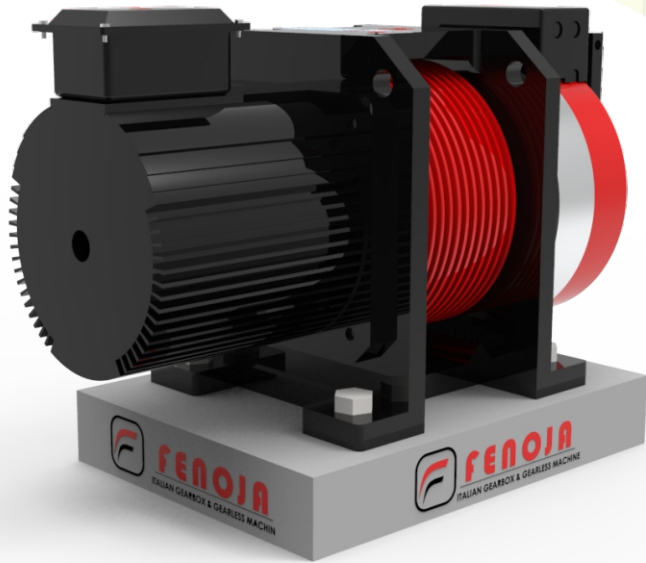

FENO-290L

Gearless Machine

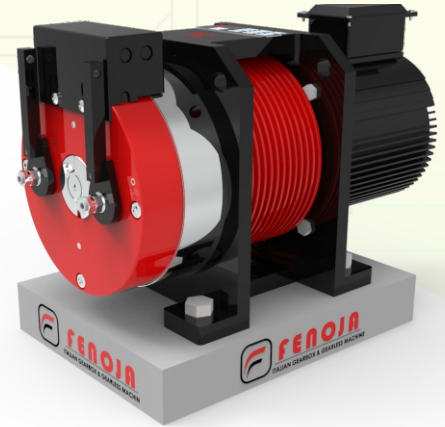

FENOJA290L Series Gearless Traction Machine Specification (Roping 2:1)

Type	Load (kg)	speed (m/s)	Power (kw)	Current (A) 380V	Speed (rpm)	Frequency (Hz)	Torque (N.m)	Sheave (mm)	Rope (nxa-b)	Brake current (A)	Net Weight (kg)
FINO450	450	1.0	3	7.6	159	21.2	180	240	5XØ6.5-11	1.5	105
	450	1.6	4.8	10.5	255	34	180	240	5XØ6.5-11	1.5	105
FINO630	630	1.0	4.2	9.3	159	21.2	250	240	6XØ6.5-11	1.75	135
	630	1.6	6.7	14	255	34	250	240	6XØ6.5-11	1.75	135
FINO800	800	1.0	5.3	10.8	159	21.2	320	240	7XØ6.5-11	1.75	155
	800	1.6	8.5	18	255	34	320	240	7XØ6.5-11	1.75	155
FINO1000	1000	1.0	6.7	13.8	159	21.2	400	240	9XØ6.5-11	1.75	200
	1000	1.6	10.7	22	255	34	400	240	9XØ6.5-11	1.75	200
FINO1250	1250	1.0	8.3	18	159	21.2	500	240	11XØ6.5-11	2	230
	1250	1.6	13.4	29	255	34	500	240	11XØ6.5-11	2	230
FINO1350	1350	1.0	9	20	159	21.2	540	240	11XØ6.5-11	2	230
	1350	1.6	14.4	32	255	34	540	240	11XØ6.5-11	2	230

Note: Other Non-Standard Parameter please contact the technical department

New Generation Permanent Magnet Synchronous Gearless Traction m/c.

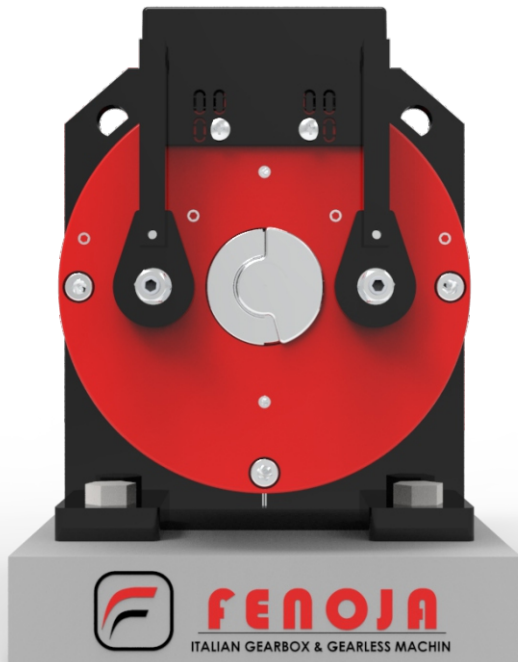

India Factory Warehouse :

 Malayapur, Raghunathpur,
24 PGS North, **Baduria** - 743401
West Bengal, India

 +91-9735-02-0007
03217-235003

 info@fenoja.com

 www.fenoja.com

